

Notes:

1. MAIN DISCONNECT PROVIDED BY OTHER.
2. FIELD WIRING TO BE COPPER RATED FOR 75°C MINIMUM.
3. - - - - INDICATES FIELD WIRING OUTSIDE OF CABINET.
4. RTD-1B & RTD-2B ON 10-15HP ONLY.
5. AUXILIARY CONTACTS LIST ON SHEET 3.
6. THE AMPACITY OF CONDUCTORS SUPPLYING THE CONTROL PANEL TO BE ROUNDED UP TO THE NEXT SIZE LARGER STANDARD WIRE GAUGE.
7. MOP VALUES TO BE ROUNDED DOWN TO THE NEAREST STANDARD RATING OF THE OVERCURRENT PROTECTION DEVICE.
8. SHORT CIRCUIT CURRENT RATING (SCCR): 65 kA

DEFAULT PUMP PSI SETTINGS

PUMP SEQUENCE	PSI
LEAD CUT-OFF	140
LAG CUT-ON	120

BACKUP PRESSURE SWT SETTINGS

BPS-1 CUT-OFF	140
BPS-1 CUT-ON	105

MINIMUM CIRCUIT AMPACITY (MCA)

SYSTEM HP	208 V	230 V	380 V	460 V
5 HP	74.5 AMPS	67.8 AMPS	43.7 AMPS	34.4 AMPS
7.5 HP	106.4 AMPS	96.7 AMPS	62.0 AMPS	48.8 AMPS
10 HP	134.4 AMPS	122.2 AMPS	79.0 AMPS	61.6 AMPS
15 HP	199.9 AMPS	181.7 AMPS	117.3 AMPS	91.3 AMPS

MAXIMUM OVERCURRENT PROTECTION (MOP)

SYSTEM HP	208 V	230 V	380 V	460 V
5 HP	87.7 AMPS	79.8 AMPS	50.9 AMPS	39.9 AMPS
7.5 HP	127.1 AMPS	115.5 AMPS	73.5 AMPS	57.8 AMPS
10 HP	161.7 AMPS	147.0 AMPS	94.5 AMPS	73.5 AMPS
15 HP	242.6 AMPS	220.5 AMPS	141.8 AMPS	110.3 AMPS

QUADRUPLEX SYSTEM FULL LOAD AMPERES

SYSTEM HP	208 V	230 V	380V/50Hz	460 V
5 HP	54.0 AMPS	50.5 AMPS	30.8 AMPS	25.6 AMPS
7.5 HP	74.8 AMPS	71.3 AMPS	39.6 AMPS	36.0 AMPS
10 HP	105.2 AMPS	98.5 AMPS	55.6 AMPS	49.6 AMPS
15 HP	157.6 AMPS	142.5 AMPS	84.0 AMPS	71.6 AMPS

INDIVIDUAL FULL LOAD AMPERES

SYSTEM HP	208 V	230 V	380V/50Hz	460 V
5 HP	12.8 AMPS	12.0 AMPS	7.2 AMPS	6.0 AMPS
7.5 HP	18.0 AMPS	17.2 AMPS	9.4 AMPS	8.6 AMPS
10 HP	25.6 AMPS	24.0 AMPS	13.4 AMPS	12.0 AMPS
15 HP	38.7 AMPS	35.0 AMPS	20.5 AMPS	17.5 AMPS

FUSE SELECTION CHART (MAX FUSE SIZES SHOWN)

SYSTEM HP	FUSES	208 V	230 V	380 V	460 V
ALL	F1/F2/F4/F5/F7/F8/F10/F11	6.0 AMPS	6.0 AMPS	6.0 AMPS	6.0 AMPS
	F3/F6/F9/F12	---	---	6.0 AMPS	6.0 AMPS
	F21-F24	4.0 AMPS	4.0 AMPS	4.0 AMPS	4.0 AMPS
	F31/F32/F33/F34	1.0 AMP	1.0 AMP	1.0 AMP	1.0 AMP
	F35	0.5 AMP	0.5 AMP	0.5 AMP	0.5 AMP

F1-F12 ARE LITTELFUSE KLDR 600V TYPE
F21-F24/F31-F35 ARE LITTELFUSE 2AG 250V TYPE

AUTO OPERATION:

DURING NORMAL OPERATION, THE MASTER PCB WILL SIGNAL THE LEAD COMPRESSOR TO START WHEN THE PRESSURE FALLS BELOW THE SET-POINT FOR THE LEAD PUMP. IF ONE PUMP CAN CARRY THE LOAD, THE PRESSURE WILL RISE TO 140 PSI. THE MASTER PCB WILL THEN SIGNAL THE PUMP PCB TO TURN OFF THE LEAD COMPRESSOR. WHEN THE SYSTEM PRESSURE DROPS AGAIN BELOW THE LEAD SET-POINT, THE MASTER PCB WILL SEQUENCE THE LEAD ROLE TO THE NEXT COMPRESSOR AND IT WILL START. IF ANY LEAD COMPRESSOR RUNS FOR MORE THAN 17 MINUTES AND CANNOT REACH 140 PSI, THE MASTER PCB WILL TURN OFF THE COMPRESSOR THAT IS RUNNING AND SEQUENCE TO THE NEXT COMPRESSOR.

PUMP PCB S1 POSITION:

POSITION (A) - AUTO (DEFAULT):

THE PUMP WILL OPERATE NORMALLY AS DESCRIBED ABOVE IN "AUTO OPERATION".

POSITION (X) - OFF:

THE PUMP IS DISABLED FROM RUNNING.

POSITION (O) - MANUAL:

THE PUMP WILL START AND STOP ON THE BACK UP PRESSURE SWITCH (BPS-1).

PCB FAULT:

IF A PUMP PCB ETHERNET FAULT OR A TRANSDUCER FAULT OCCURS, THE PUMP PCB WILL AUTOMATICALLY SWITCH TO MANUAL MODE. COMPRESSORS WILL START WHEN BPS-1 (BACKUP PRESSURE SWITCH) CLOSES AND STOP WHEN IT OPENS. COMPRESSORS WILL NOT SEQUENCE IN THIS CONDITION AND CAN OPERATE UNTIL THE ETHERNET OR TRANSDUCER FAULT IS REPAIRED.

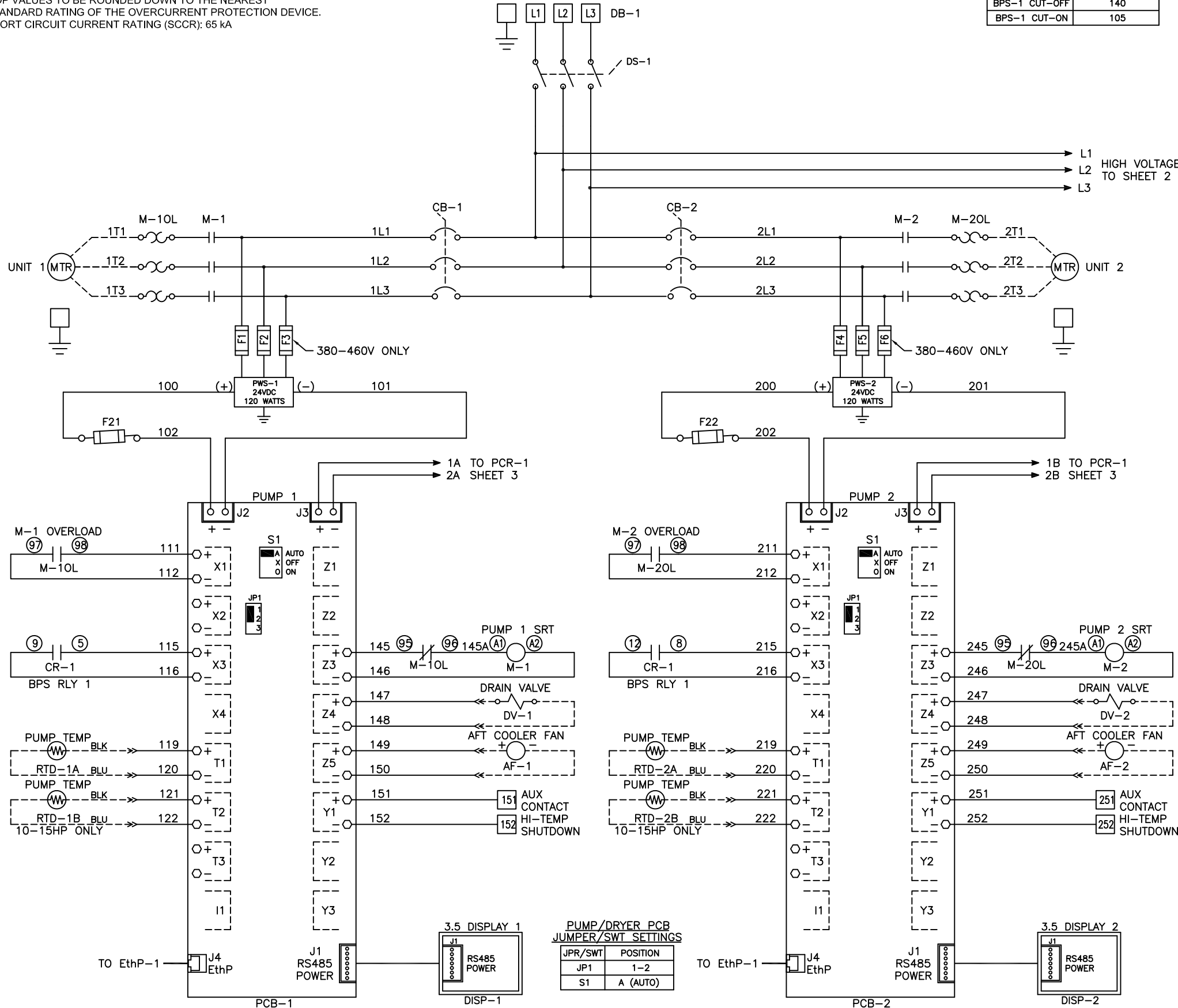

PUMP/DRYER PCB JUMPER/SWT SETTINGS

JPR/SWT	POSITION
JP1	1-2
S1	A (AUTO)

Revised: BM	Date: 01/12/22	Drawn: MDB	Date: 10/30/18
		Scale: NTS D	
Description: DWG WIRING CONTROL QX LAB SCROLL 5-15HP 208-460/3/50-60, 65KA		Part Number: 4107 8568 35 DN: HOP211246 Sheet 1 of 3	

Notes:

1. FIELD WIRING TO BE COPPER RATED FOR 75°C MINIMUM.
2. - - - - INDICATES FIELD WIRING OUTSIDE OF CABINET.
3. RTD-3B & RTD-4B ON 10-15HP ONLY.

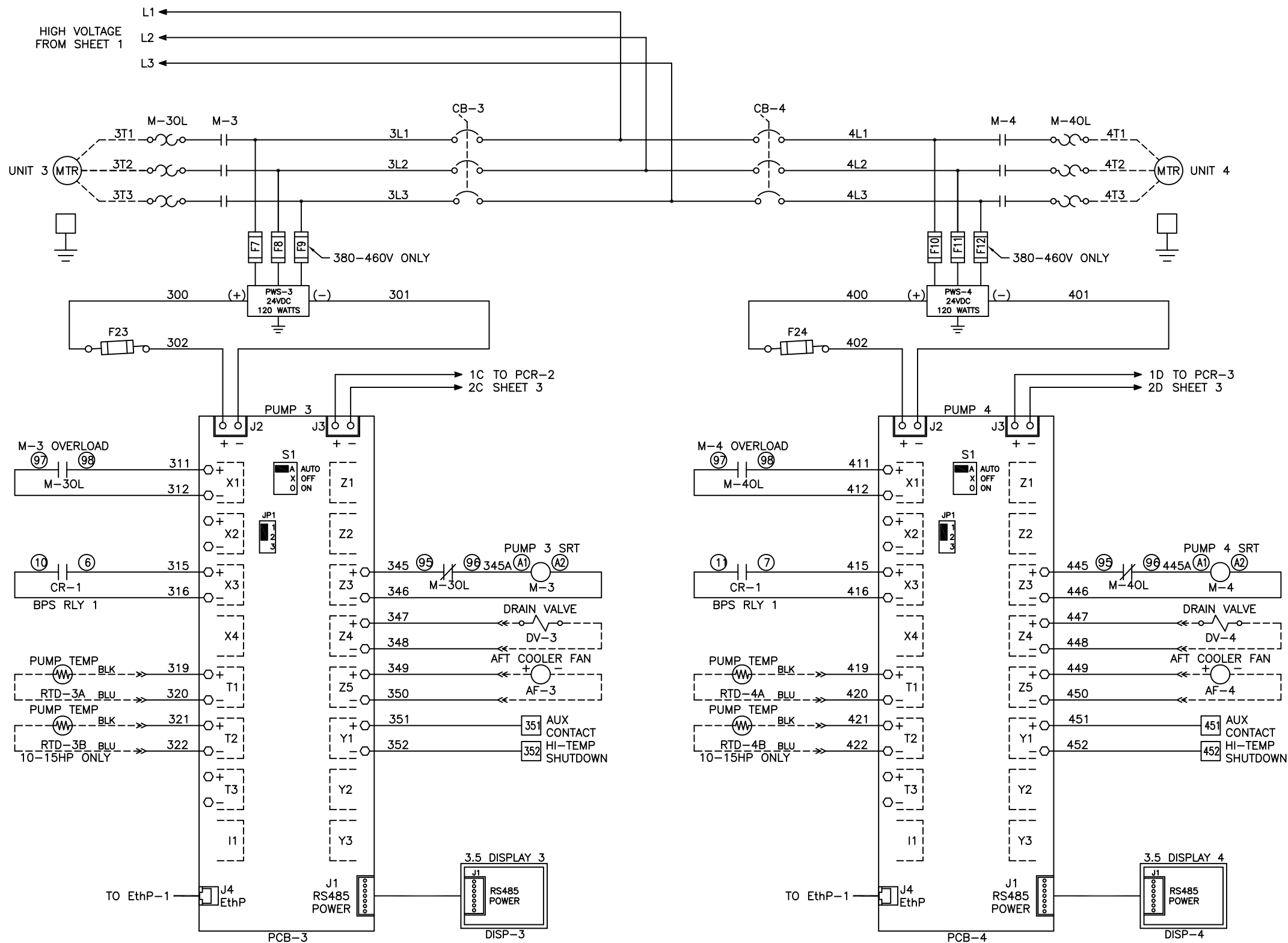

PUMP/DRYER PCB JUMPER/SWT SETTINGS

JPR/SWT	POSITION
JP1	1-2
S1	A (AUTO)

Revised: BM	Date: 01/12/22	Drawn: MDB	Date: 10/30/18
This drawing and the information contained therein remain the property of BeaconMedes and may not be used for other than the purpose for which it is loaned without the expressed written permission from BeaconMedes Engineering.			Scale: NTS
Description: DWG WIRING CONTROL QX LAB SCROLL 5-15HP 208-460/3/50-60, 65kA		Part Number: 4107 8568 35	
DWN: HOP211246		Rev: 02	
Sheet 2 of 3		DO NOT SCALE THIS DOCUMENT	

Notes:

1. FIELD WIRING TO BE COPPER RATED FOR 75°C MINIMUM.
2. - - - - - INDICATES FIELD WIRING OUTSIDE OF CABINET.

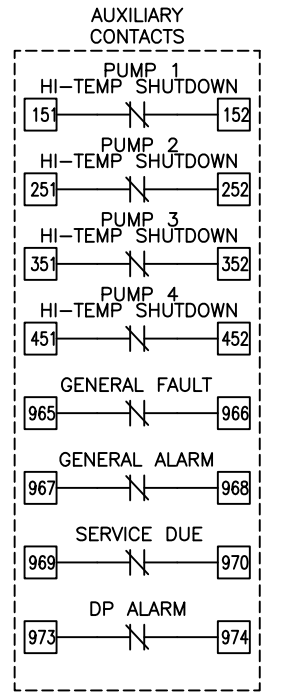
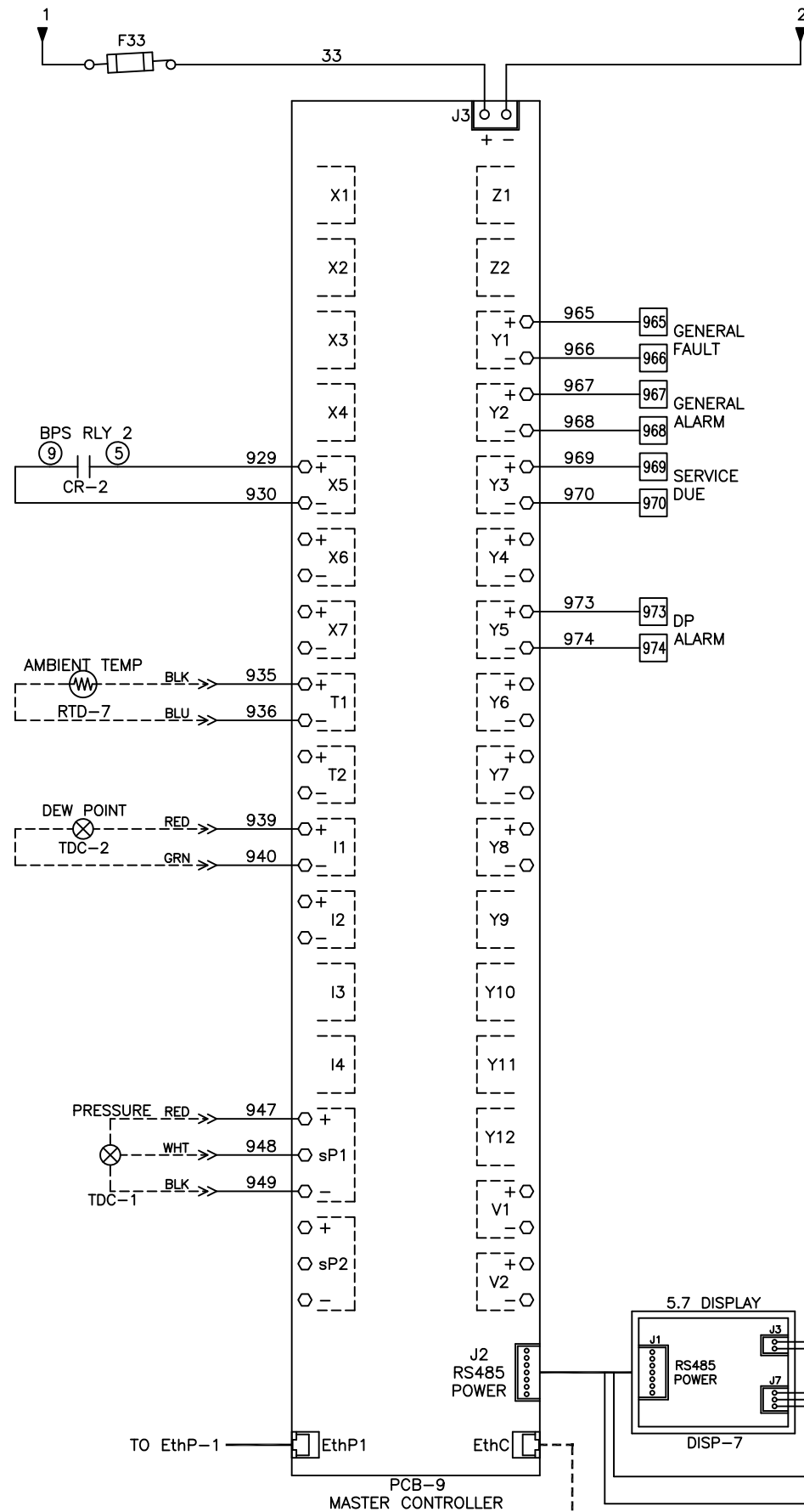
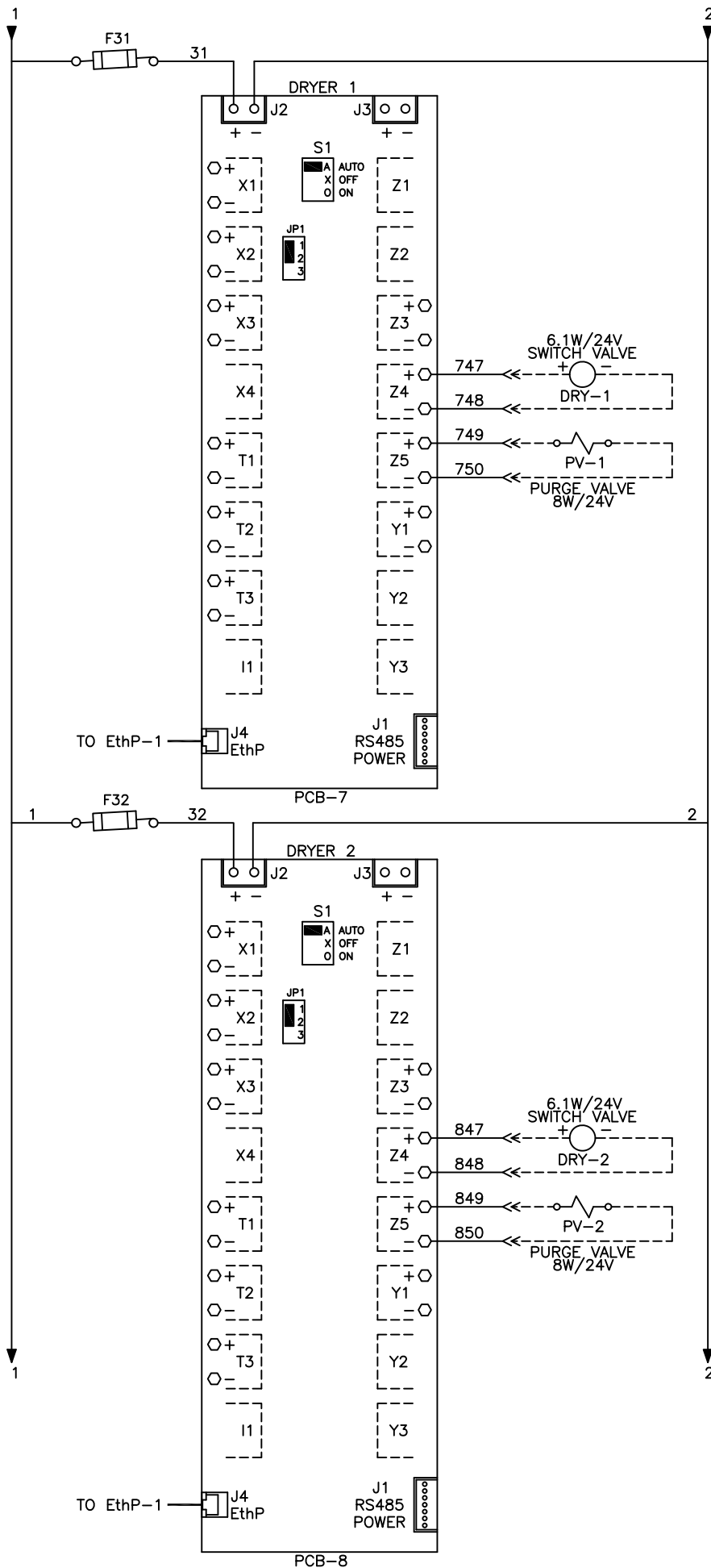
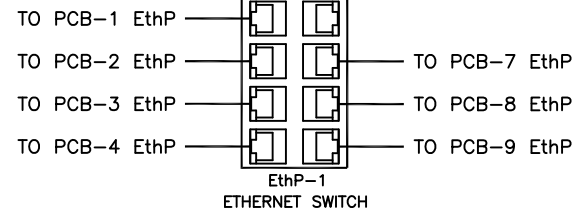
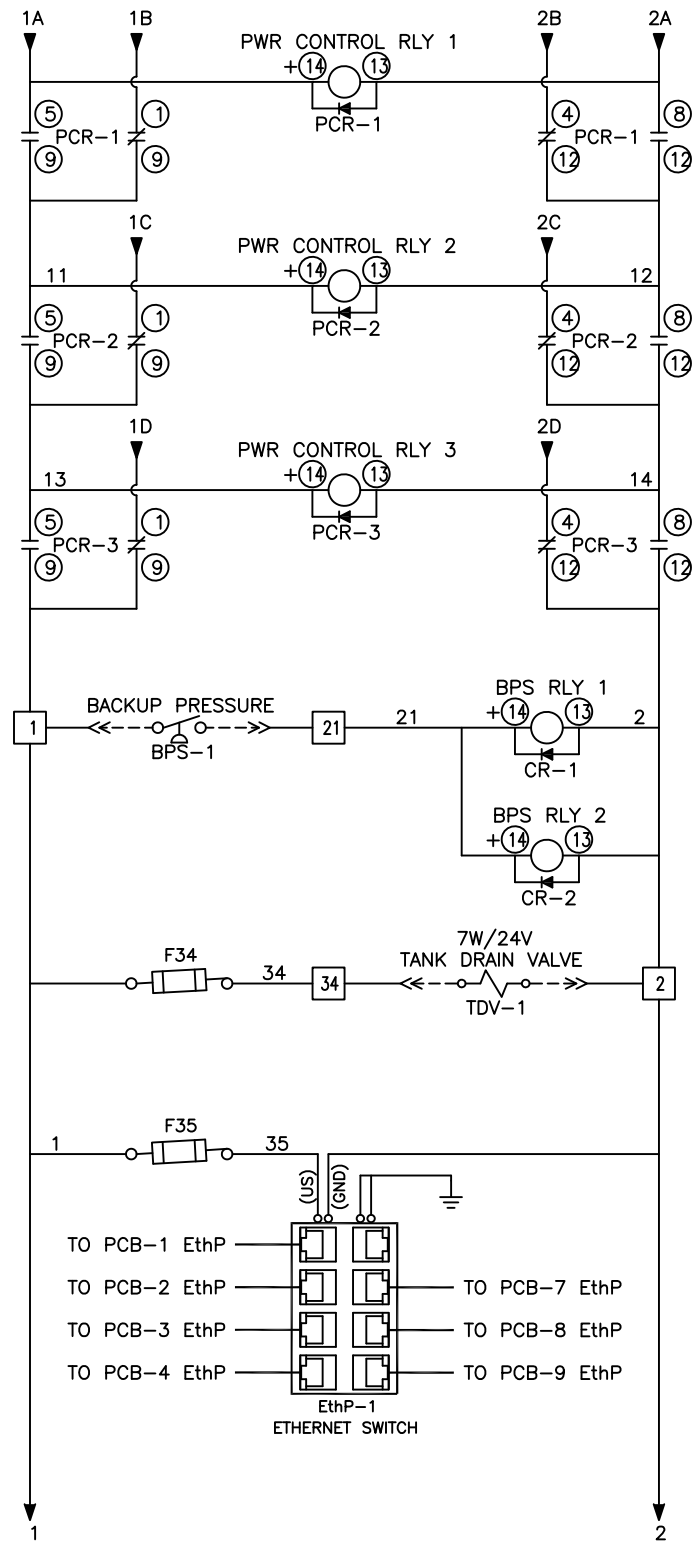

NOTE:
 AUXILIARY CONTACTS
 151-152, 251-252,
 351-352, 451-452,
 965-970, & 973-974
 ARE "CLASS 1 CONTROL
 CIRCUITS. USE CLASS 1
 CONDUCTORS."

AUX CONTACTS ARE RATED
 0.7Adc/0.7Arms @ 24V
 MAX. UNLESS OTHERWISE
 NOTED.

AUX CONTACTS CLOSED
 DURING NORMAL
 OPERATION.

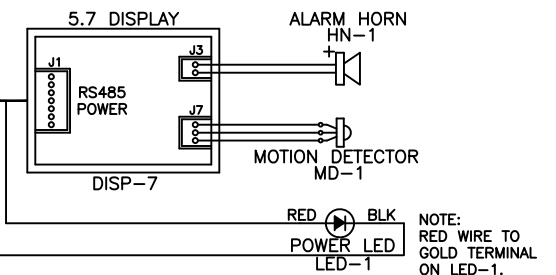

NOTE:
 RED WIRE TO
 GOLD TERMINAL
 ON LED-1.

Revised: BM	Date: 01/12/22	Drawn: MDB	Date: 10/30/18
<p>This drawing and the information contained therein remain the property of BeaconMedes and may not be used for other than the purpose for which it is loaned without the expressed written permission from BeaconMedes Engineering.</p>			
<p>Part Number: 4107 8568 35</p>		<p>Scale: NTS</p>	
<p>DN: HOP211246</p>		<p>Rev: 02</p>	
<p>Sheet 3 of 3</p>		<p>DO NOT SCALE THIS DOCUMENT</p>	

DESCRIPTION:
 DWG WIRING CONTROL
 OX LAB SCROLL 5-15HP
 208-460/3/50-60, 65kA