

Notes:

1. MAIN DISCONNECT PROVIDED BY OTHER.
2. FIELD WIRING TO BE COPPER RATED FOR 75°C MINIMUM.
3. - - - - - INDICATES FIELD WIRING OUTSIDE OF CABINET.
4. RTD-1B & RTD-2B ON 10-15HP ONLY.
5. AUXILIARY CONTACTS LIST ON SHEET 2.
6. THE AMPACITY OF CONDUCTORS SUPPLYING THE CONTROL PANEL TO BE ROUNDED UP TO THE NEXT SIZE LARGER STANDARD WIRE GAUGE.
7. MOP VALUES TO BE ROUNDED DOWN TO THE NEAREST STANDARD RATING OF THE OVERCURRENT PROTECTION DEVICE.
8. SHORT CIRCUIT CURRENT RATING (SCCR): 65 kA
9. 60A FUSE BLOCKS ARE NOT USED DUE TO SIZE CONSTRAINTS.

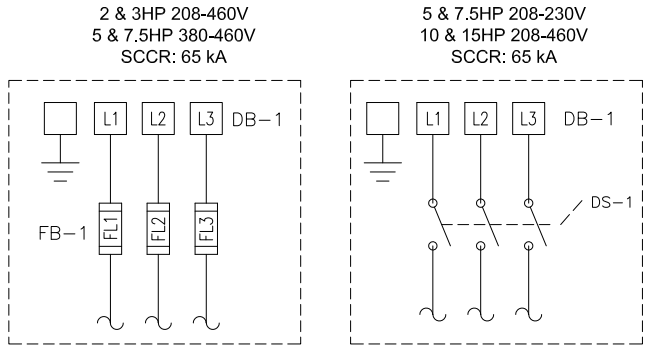

MINIMUM CIRCUIT AMPACITY (MCA)

SYSTEM HP	208 V	230 V	380 V	460 V
2 HP	18.6 AMPS	16.9 AMPS	10.9 AMPS	8.7 AMPS
3 HP	25.6 AMPS	23.2 AMPS	15.0 AMPS	11.8 AMPS
5 HP	39.3 AMPS	35.8 AMPS	23.1 AMPS	18.1 AMPS
7.5 HP	56.2 AMPS	51.1 AMPS	32.8 AMPS	25.8 AMPS
10 HP	71.1 AMPS	64.6 AMPS	41.8 AMPS	32.5 AMPS
15 HP	105.7 AMPS	96.1 AMPS	62.0 AMPS	48.3 AMPS

DEFAULT PUMP PSI SETTINGS

PUMP SEQUENCE	PSI
LEAD CUT-OFF	140
LAG CUT-ON	120

BACKUP PRESSURE SWT SETTINGS

BPS-1 CUT-OFF	PSI
BPS-1 CUT-OFF	140
BPS-1 CUT-ON	105

PUMP/DRYER PCB JUMPER/SWT SETTINGS

JPR/SWT	POSITION
JP1	1-2
S1	A (AUTO)

MAXIMUM OVERCURRENT PROTECTION (MOP)

SYSTEM HP	208 V	230 V	380 V	460 V
2 HP	24.4 AMPS	22.1 AMPS	14.0 AMPS	11.1 AMPS
3 HP	34.5 AMPS	31.2 AMPS	19.8 AMPS	15.6 AMPS
5 HP	54.3 AMPS	49.4 AMPS	31.5 AMPS	24.7 AMPS
7.5 HP	78.7 AMPS	71.5 AMPS	45.5 AMPS	35.8 AMPS
10 HP	100.1 AMPS	91.0 AMPS	58.5 AMPS	45.5 AMPS
15 HP	150.2 AMPS	136.5 AMPS	87.8 AMPS	68.3 AMPS

DUPLEX SYSTEM FULL LOAD AMPERES

SYSTEM HP	208 V	230 V	380V/50Hz	460 V
2 HP	13.0 AMPS	12.9 AMPS	8.8 AMPS	6.6 AMPS
3 HP	17.4 AMPS	16.5 AMPS	11.0 AMPS	8.4 AMPS
5 HP	27.0 AMPS	25.3 AMPS	15.4 AMPS	12.8 AMPS
7.5 HP	37.4 AMPS	35.7 AMPS	19.8 AMPS	18.0 AMPS
10 HP	52.6 AMPS	49.3 AMPS	27.8 AMPS	24.8 AMPS
15 HP	78.8 AMPS	71.3 AMPS	42.0 AMPS	35.8 AMPS

INDIVIDUAL FULL LOAD AMPERES

SYSTEM HP	208 V	230 V	380V/50Hz	460 V
2 HP	5.8 AMPS	5.8 AMPS	3.9 AMPS	2.9 AMPS
3 HP	8.0 AMPS	7.6 AMPS	5.0 AMPS	3.8 AMPS
5 HP	12.8 AMPS	12.0 AMPS	7.2 AMPS	6.0 AMPS
7.5 HP	18.0 AMPS	17.2 AMPS	9.4 AMPS	8.6 AMPS
10 HP	25.6 AMPS	24.0 AMPS	13.4 AMPS	12.0 AMPS
15 HP	38.7 AMPS	35.0 AMPS	20.5 AMPS	17.5 AMPS

FUSE SELECTION CHART (MAX FUSE SIZES SHOWN)

SYSTEM HP	FUSES	208 V	230 V	380 V	460 V
2 HP	FL1/FL2/FL3	17.5 AMPS	17.5 AMPS	12 AMPS	12 AMPS
3 HP		25 AMPS	25 AMPS	15 AMPS	12 AMPS
5 HP		---	---	20 AMPS	17.5 AMPS
7.5 HP		---	---	25 AMPS	25 AMPS
10 HP		---	---	---	---
15 HP		---	---	---	---
ALL	F1/F2/F4/F5	6.0 AMPS	6.0 AMPS	6.0 AMPS	6.0 AMPS
	F3/F6	---	---	6.0 AMPS	6.0 AMPS
	F21/F22	4.0 AMPS	4.0 AMPS	4.0 AMPS	4.0 AMPS
	F31/F32/F33/F34	1.0 AMP	1.0 AMP	1.0 AMP	1.0 AMP
	F35	0.5 AMP	0.5 AMP	0.5 AMP	0.5 AMP

FL1/FL2/FL3 ARE LITTELFUSE JTD 600V TYPE
F1-F6 ARE LITTELFUSE KLDK 600V TYPE
F21-F22/F31-F35 ARE LITTELFUSE 2AG 250V TYPE

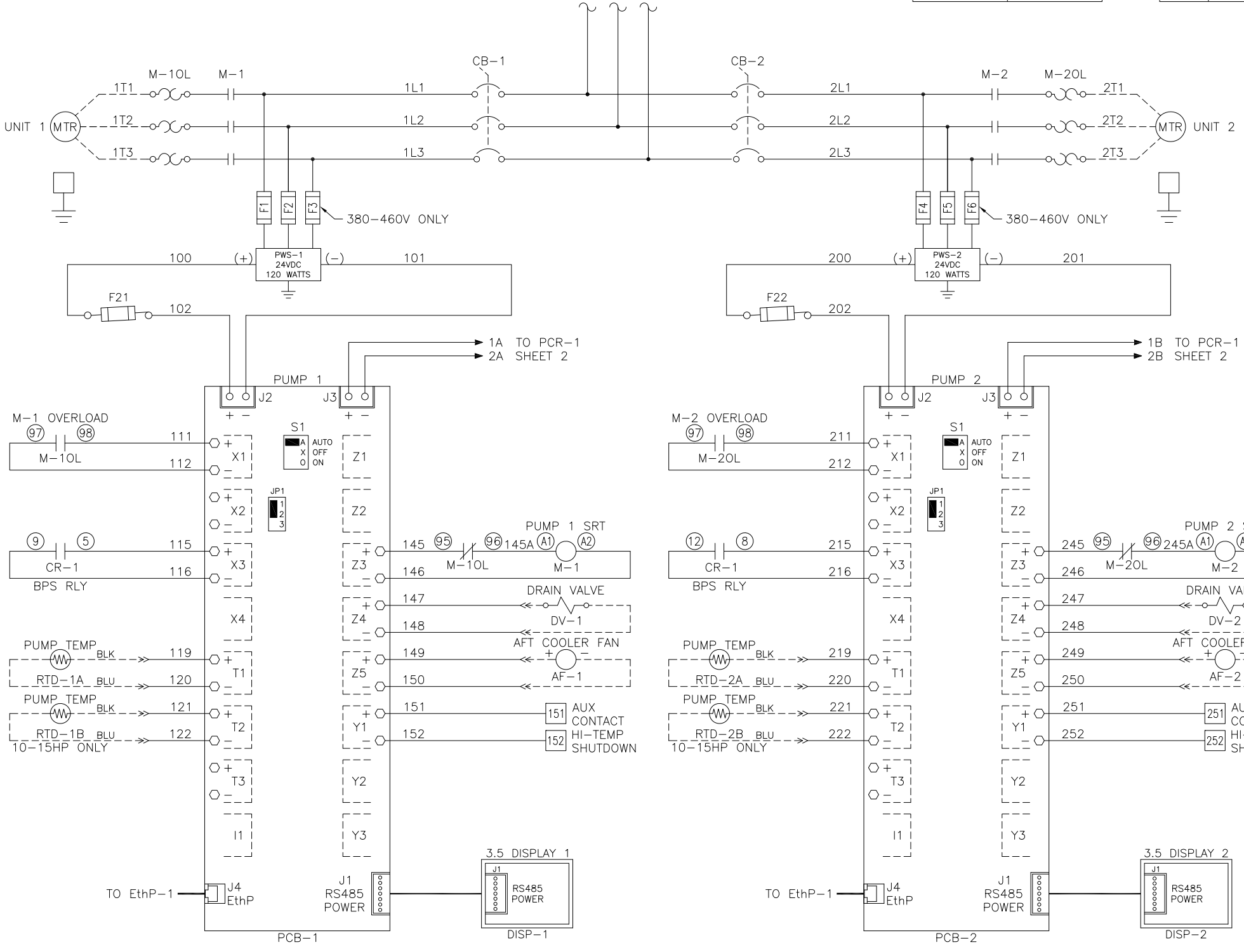

AUTO OPERATION:

DURING NORMAL OPERATION, THE MASTER PCB WILL SIGNAL THE LEAD COMPRESSOR TO START WHEN THE PRESSURE FALLS BELOW THE SET-POINT FOR THE LEAD PUMP. IF ONE PUMP CAN CARRY THE LOAD, THE PRESSURE WILL RISE TO 140 PSI. THE MASTER PCB WILL THEN SIGNAL THE PUMP PCB TO TURN OFF THE LEAD COMPRESSOR. WHEN THE SYSTEM PRESSURE DROPS AGAIN BELOW THE LEAD SET-POINT, THE MASTER PCB WILL SEQUENCE THE LEAD ROLE TO THE OTHER COMPRESSOR AND IT WILL START. IF ANY LEAD COMPRESSOR RUNS FOR MORE THAN 17 MINUTES AND CANNOT REACH 140 PSI, THE MASTER PCB WILL TURN OFF THE COMPRESSOR THAT IS RUNNING AND SEQUENCE TO THE OTHER COMPRESSOR.

PUMP PCB S1 POSITION:

POSITION (A) - AUTO (DEFAULT):
THE PUMP WILL OPERATE NORMALLY AS DESCRIBED ABOVE IN "AUTO OPERATION".
POSITION (X) - OFF:
THE PUMP IS DISABLED FROM RUNNING.
POSITION (O) - MANUAL:
THE PUMP WILL START AND STOP ON THE BACK UP PRESSURE SWITCH (BPS-1).

PCB FAULT:

IF A PUMP PCB ETHERNET FAULT OR A TRANSDUCER FAULT OCCURS, THE PUMP PCB WILL AUTOMATICALLY SWITCH TO MANUAL MODE. COMPRESSORS WILL START WHEN BPS-1 (BACKUP PRESSURE SWITCH) CLOSES AND STOP WHEN IT OPENS. COMPRESSORS WILL NOT SEQUENCE IN THIS CONDITION AND CAN OPERATE UNTIL THE ETHERNET OR TRANSDUCER FAULT IS REPAIRED.

Revised: GTM	Date: 08/28/20	Drawn: MDB	Date: 10/30/18
		Scale: NTS D	
Description: DWG WIRING CONTROL DX LAB SCROLL 2-15HP 208-460/3/50-60, 65KA		Part Number: 4107 8568 33 DN: HOP200453 Rev: 01 Sheet 1 of 2	

Notes:

- 1. FIELD WIRING TO BE COPPER RATED FOR 75°C MINIMUM.
- 2. - - - - - INDICATES FIELD WIRING OUTSIDE OF CABINET.

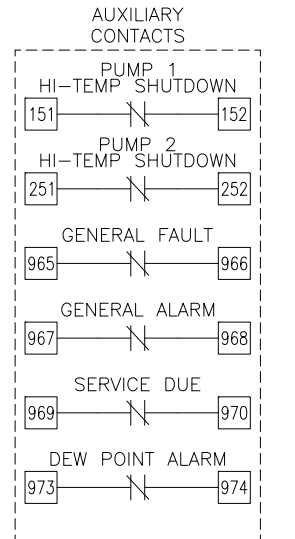
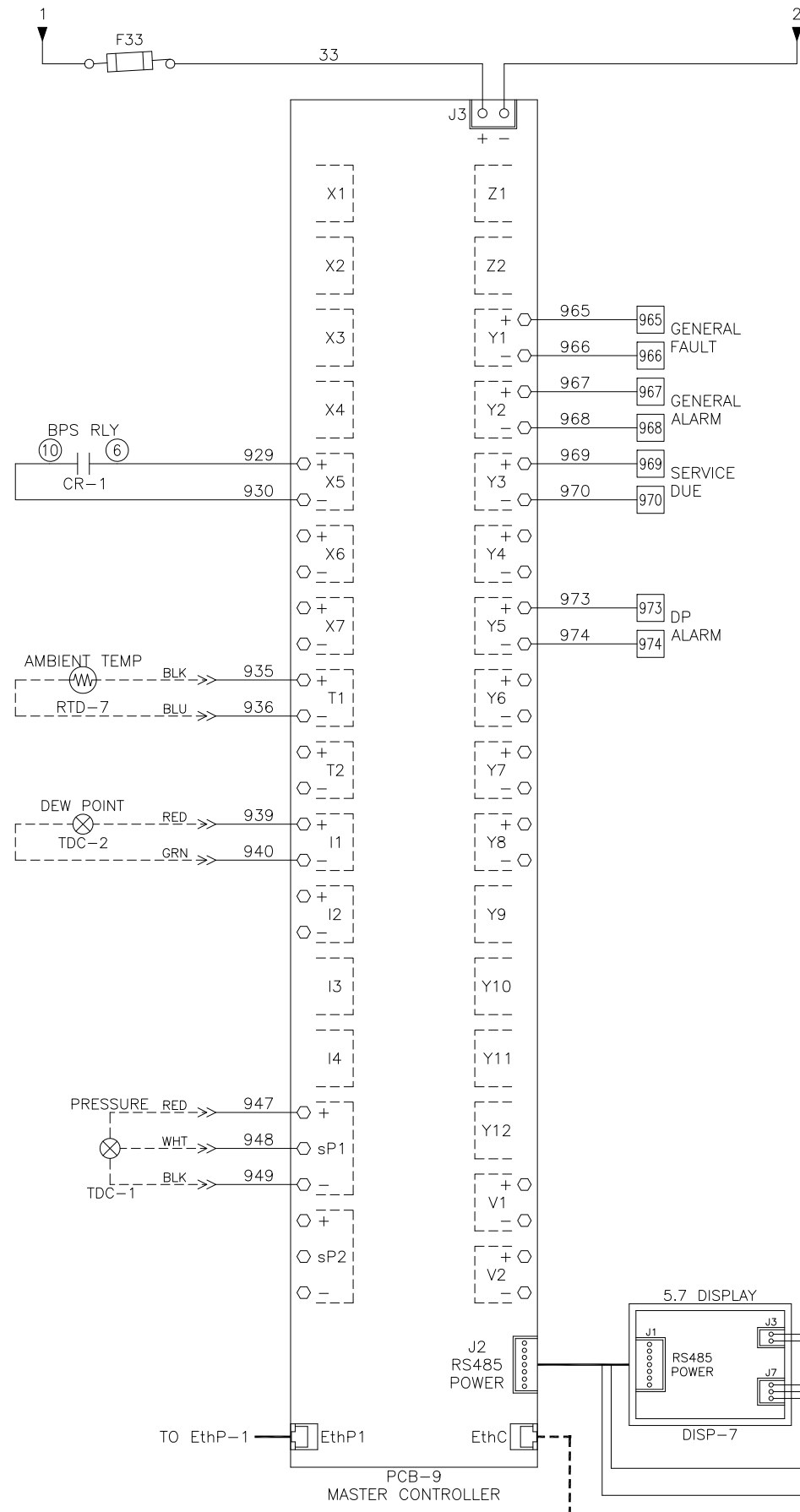
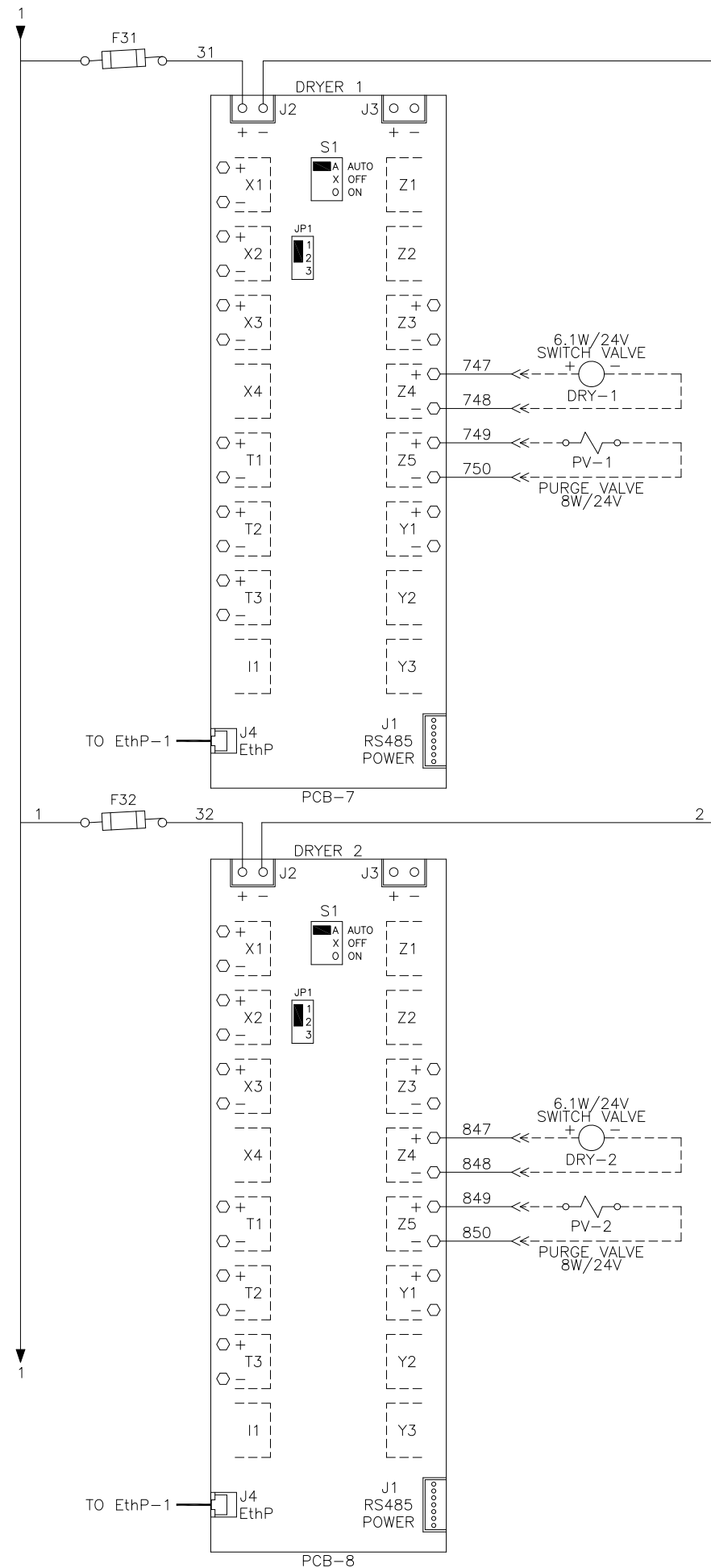
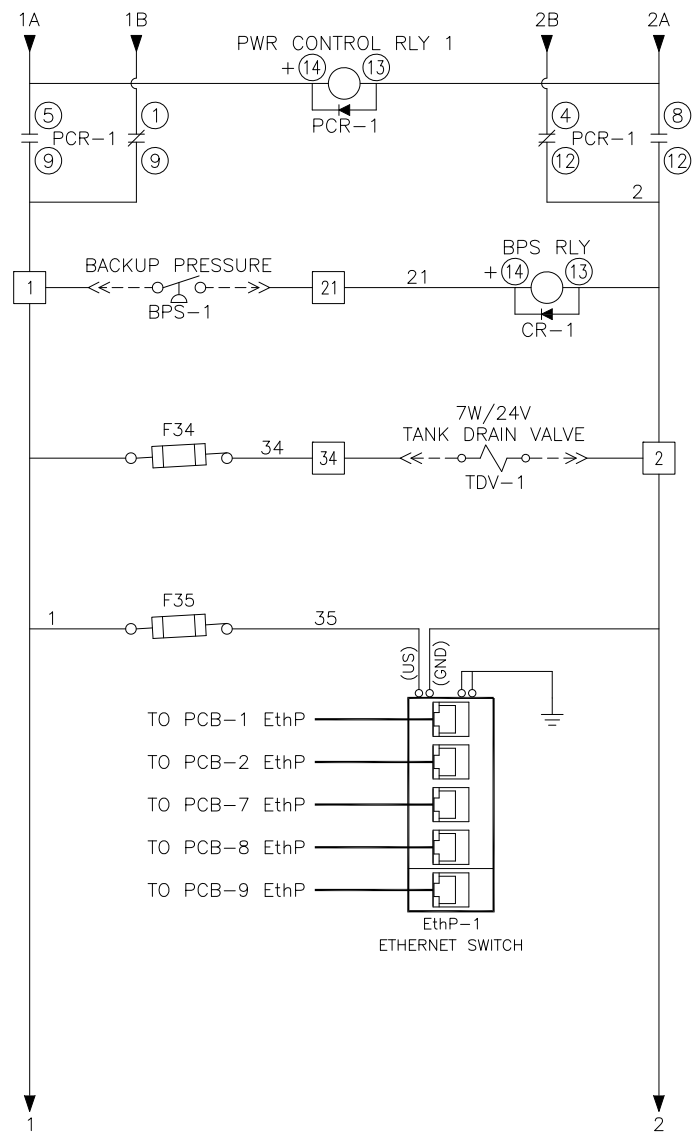

NOTE:
AUXILIARY CONTACTS
151-152, 251-252,
965-970, & 973-974
ARE "CLASS 1 CONTROL
CIRCUITS. USE CLASS 1
CONDUCTORS."

AUX CONTACTS ARE RATED
0.7A_{dc}/0.7A_{rms} @ 24V
MAX. UNLESS OTHERWISE
NOTED.

AUX CONTACTS CLOSED
DURING NORMAL
OPERATION.

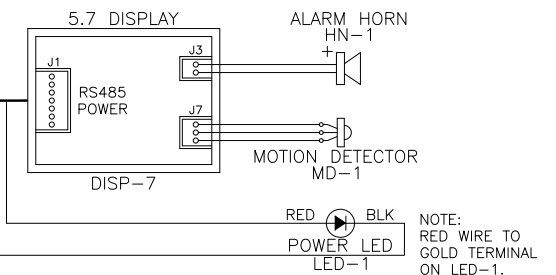

Revised: GTM	Date: 08/28/20	Drawn: MDB	Date: 10/30/18
		This drawing and the information contained thereon remain the property of BeaconMedes and may not be used for other than the purpose for which it is loaned without the expressed written permission from BeaconMedes Engineering.	
Description: DWG WIRING CONTROL DX LAB SCROLL 2-15HP 208-460/3/50-60, 65kA		Part Number: 4107 8568 33	
DN:	HOP200453	Rev:	01
Sheet 2 of 2		DO NOT SCALE THIS DOCUMENT	