

MODEL NUMBER	UNIT (HP)	PUMP MODEL	RECEIVER (GALLONS)	WEIGHT (lbs.)		
				SIMPLEX MODULE	SIMPLEX MODULE WITH CONTROL PANEL	RECEIVER MODULE
LVS-10D-RC220V	10	GL-35	220	1124	1348	565

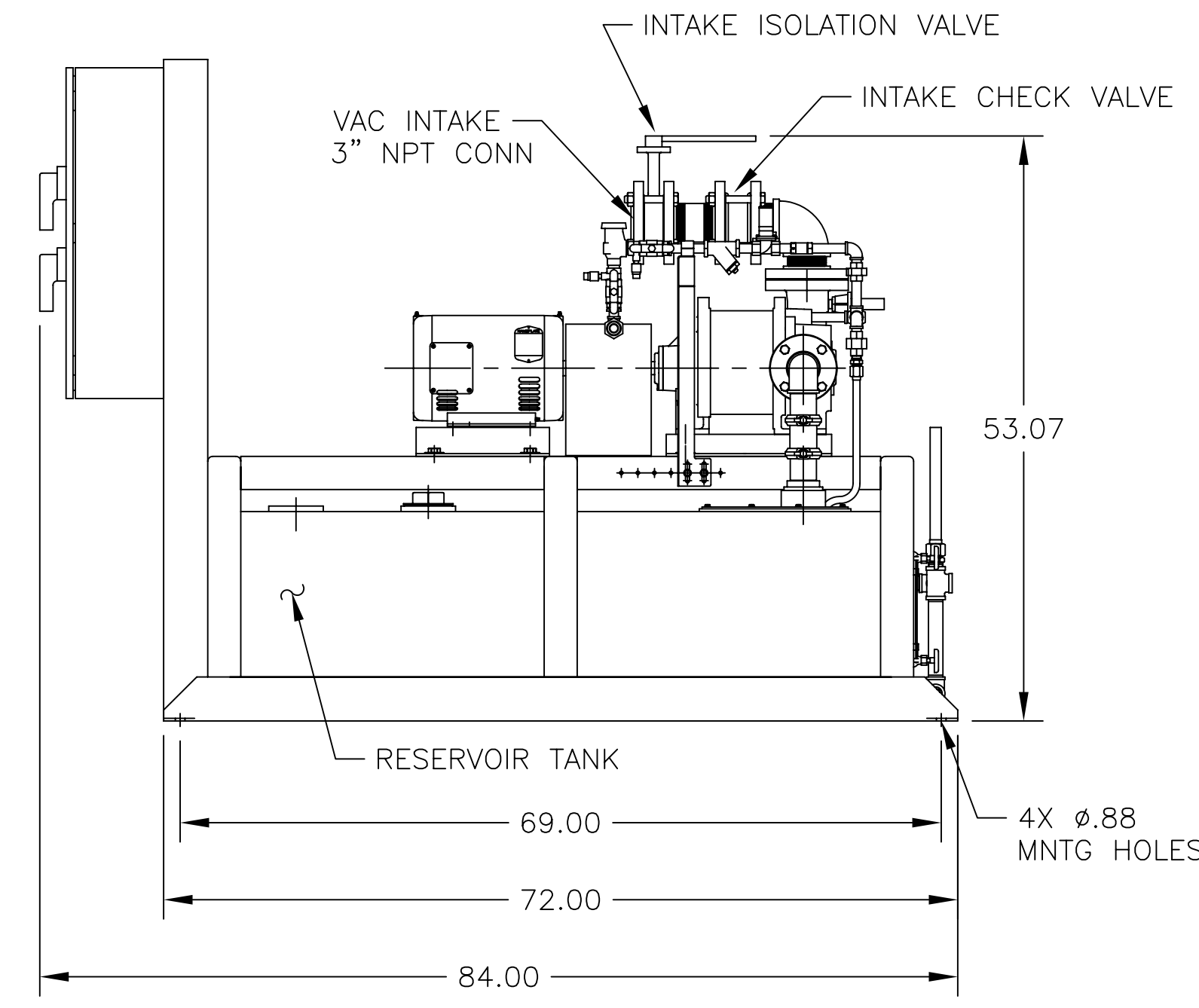
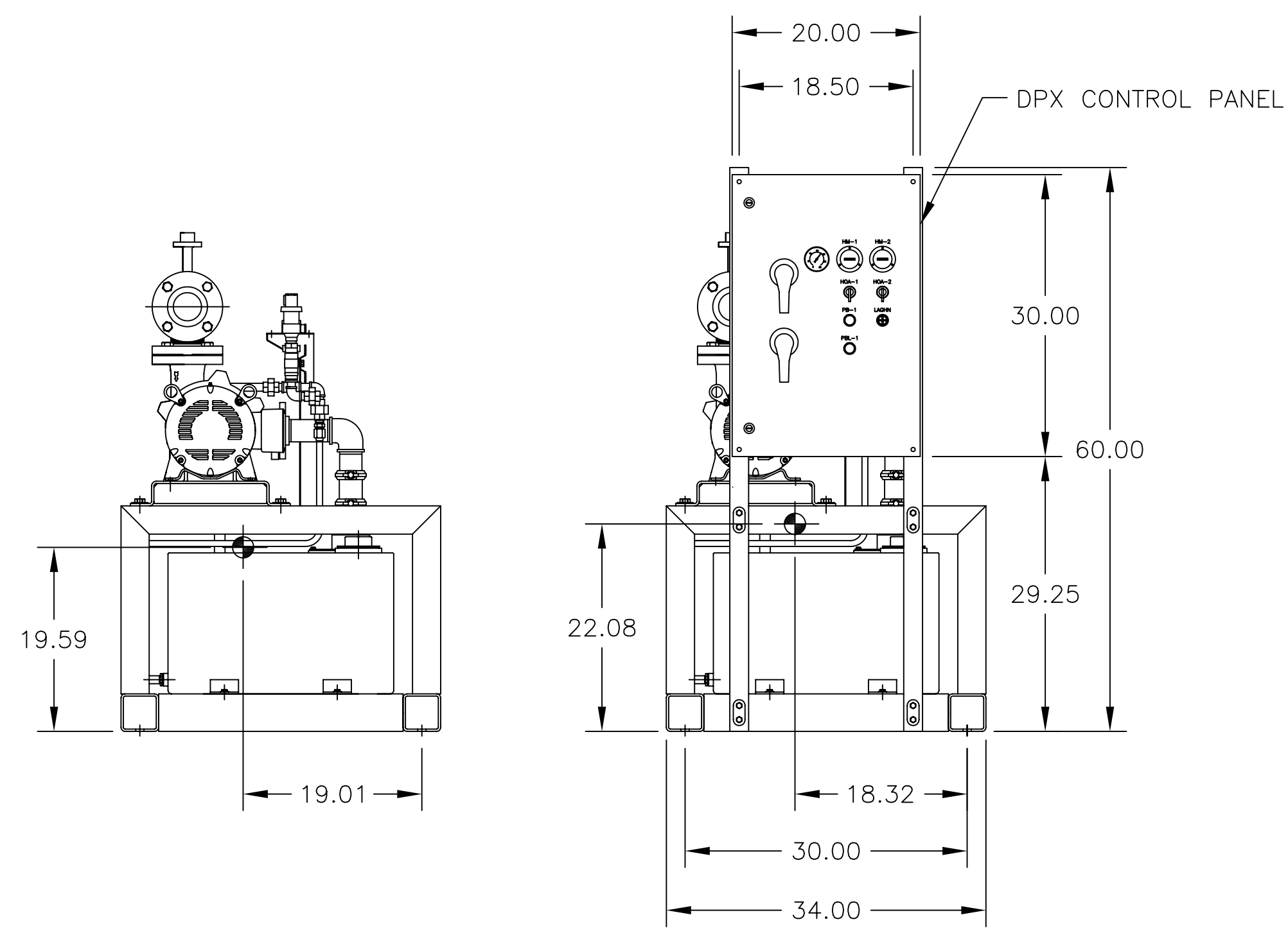
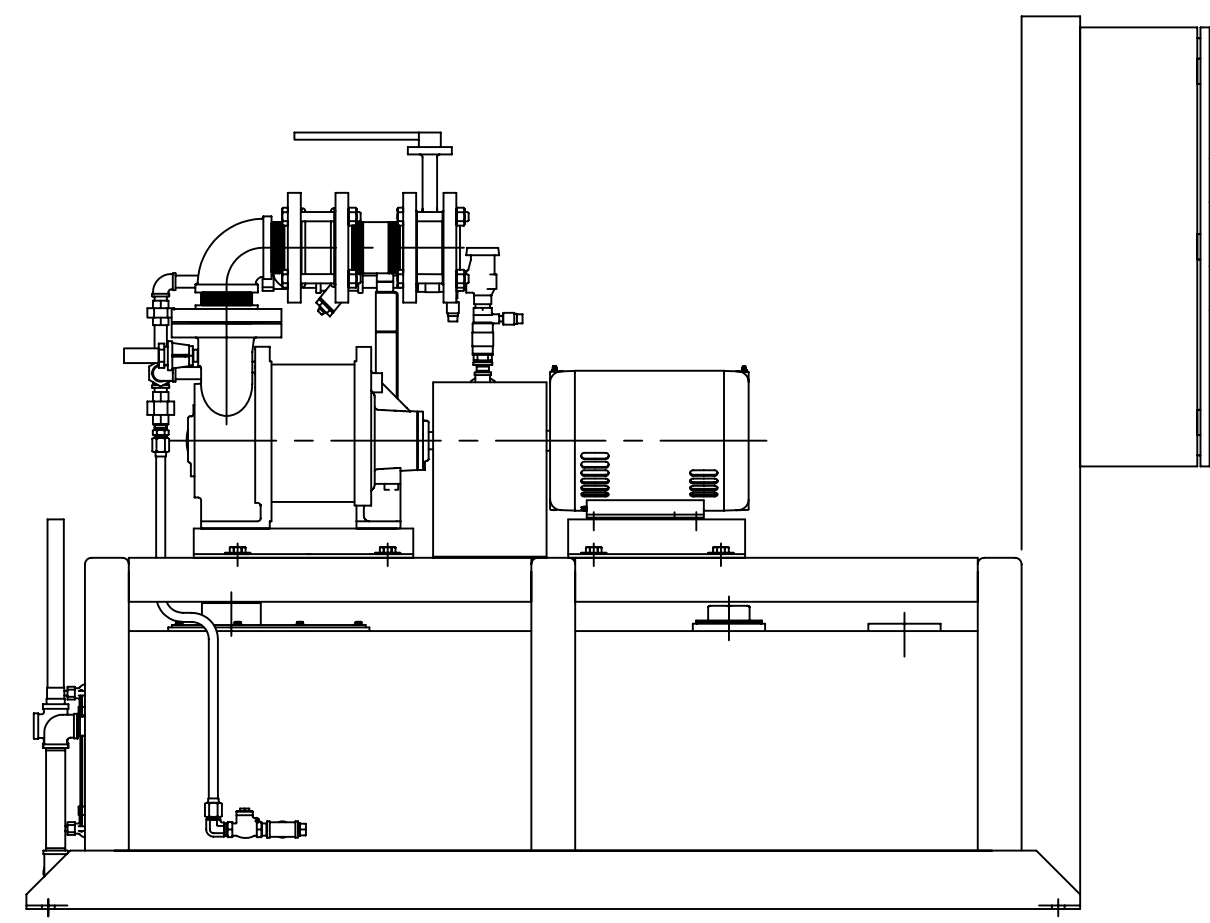
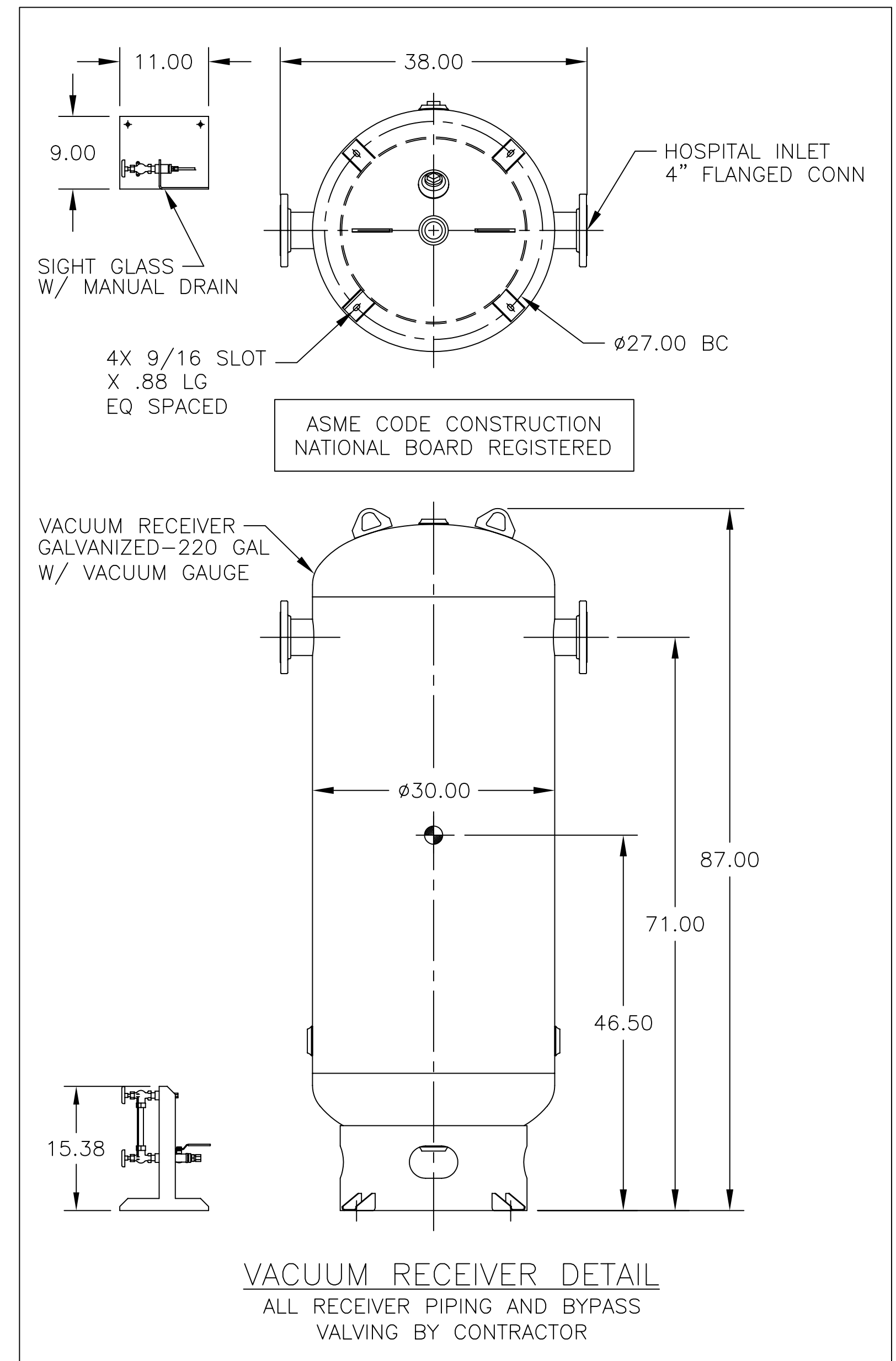
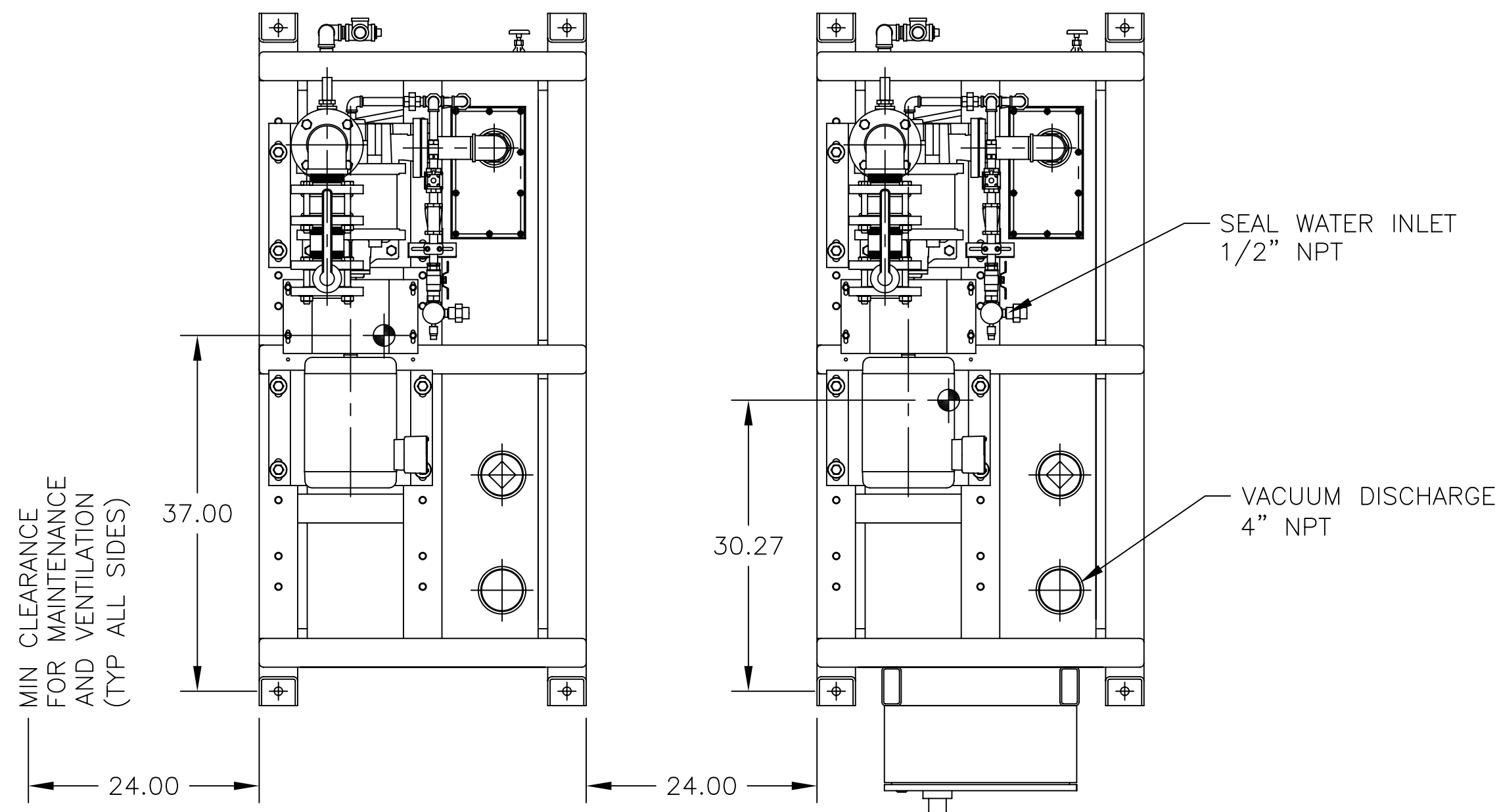

- NOTE:
1. FLEX HOSES ARE SHIPPED LOOSE.
  2. ALL WIRING AND INTAKE MANIFOLD BETWEEN MODULES SUPPLIED BY OTHERS.
  3. INDICATES CENTER OF GRAVITY.

**BEACONMEDÆS**

TITLE:  
LL DPX CAMEL TYPE 2 VACUUM SYSTEM  
GENERAL ASSEMBLY - GL-35/10HP

DRAWN BY: T. FELLER	DATE: 09/06/05	This drawing and the information contained thereon remain the property of BeaconMedæS and may not be used for other than the purpose for which it is loaned without the expressed written permission from BeaconMedæS Engineering.
CHECKED BY: T. CONNER	DATE: 09/06/05	
REVISED BY: T. FELLER	DATE: 01/29/08	
SCALE: 1/14	D	
DRAWING NO. DIA 24 202		REV. B